



Barleystone Ltd
Taghart South, Shercock, Co. Cavan, Ireland

13

EN 771-3:2011
Category II, Half 4" Airtight, Aggregate Concrete Masonry Unit

Dimensions: Length 220mm, Width 100mm, Height 215mm

Dimensional Tolerance:

Category: D2
Flatness: NPD
Plane parallelism: NPD

Configuration: Solid, as in attached drawing

Compressive Strength: 10 N/mm² (bedface). (Cat II)

Dimensional Stability: Moisture Movement: NPD

Shear Bond Strength: NPD

Flexural Bond Strength: NPD

Reaction to Fire: Euroclass A1

Water absorption: Not to be left exposed

Water vapour diffusion coefficient: NPD

Direct airborne sound insulation: NPD

Thermal Conductivity: NPD

Durability against freeze-thaw: Not to be left exposed

Dangerous Substances: NPD

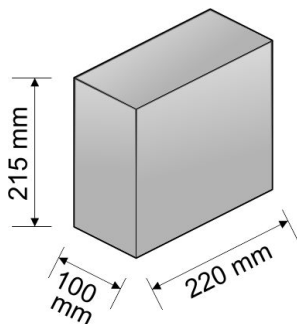

DECLARATION OF PERFORMANCE

Barleystone Ltd, Taghart South, Shercock, Co. Cavan (place of production)

Confirms that:

Half 4" Airtight Masonry Block

Conforms to the Harmonised Standard: EN 771-3:2011, Category II,

220mm x 100mm x 215mm Aggregate Concrete Masonry Unit

Provision to which the product conforms: Standard: Annex ZA of EN 771-3:2011, System 4

Dimensional Tolerance: Category D2
Configuration: Solid, As in attached drawing
Compressive Strength: 10 N/mm² (bedface). (Cat II)
Dimensional Stability: Moisture Movement: NPD
Shear Bond Strength: NPD
Flexural Bond Strength: NPD
Reaction to Fire: Euroclass A1
Water absorption: Not to be left exposed
Water vapour diffusion coefficient: NPD
Direct airborne sound insulation: NPD
Thermal Conductivity: NPD
Durability against freeze-thaw: Not to be left exposed
Dangerous Substances: NPD

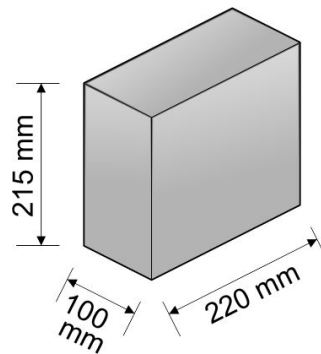

The performance of the product identified above is in conformity with the declared values, when installed in accordance with the manufacturer's instructions and general purpose or lightweight mortars.

Signed: 

Full name: Darragh O'Reilly
Position: Managing Director
Date: 26 June 2013